

## Žárovky pro speciální aplikace - Broadway ⇒ Broadway halogenové žárovky Broadway Studio/Film jednopaticové

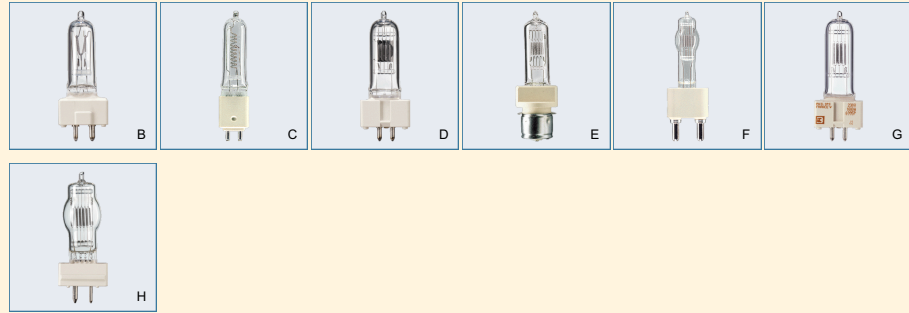

### Světelný zdroj:

- Halogenové žárovky napájené síťovým napětím s různými verzemi vláken - dvuplošné, jednoplošné, vinutá cívka a tvar M
- Většina žárovek používá technologii P3

### Vlastnosti:

- Vysoká svítivost

- Všechny žárovky mají teplotu chromatičnosti 3200K
- Technologie P3 zajišťuje spolehlivost, kvalitu a víceúčelovost:
  - Spolehlivost - delší životnost s menším počtem předčasných selhání

- Kvalita - skvělé vlastnosti pro uskladnění a trvalý výkon po celou dobu životnosti
- Víceúčelovost - různé konstrukce svítidel a různé provozní polohy

### Použití:

- Studiové a filmové osvětlení
- Osvětlení diskoték
- Divadelní světla

Typ	Název produktu					Druh zapalovače	Tvar vlákna	Světelný tok (lm)	Poloha svícení	Obr. č.	Foto písmeno	Objednací kód
	Příkon	Patice	Napětí	Typ balení	Uspořádání balení							
6872P	300W	GY9.5	230V	1CT	10	-	M	7050	Univerzální	1	B	8711500... 187833 25
6872P	300W	GY9.5	240V	1CT	10	-	M	7050	Univerzální	1	B	187598 25
7389	500W	GY9.5	230V	1CT	10	-	Bi-Plane	14000	S90	2	B	187192 25
6873P	500W	GY9.5	230V	1CT	10	-	M	13500	Univerzální	3	B	187871 25
7389	500W	GY9.5	240V	1CT	10	-	Bi-Plane	14000	S90	2	B	187239 25
6873P	500W	GY9.5	240V	1CT	10	-	M	13500	Univerzální	3	B	187635 25
6985P	575W	G9.5	115V	1CT	10	P3 Technology	Coiled Coil	16500	Univerzální	4	C	495983 25
6993Z	650W	G22	230V	1CT	10	P3 Technology	Bi-Plane	16500	Univerzální	5	A	185716 25
6999P	650W	GX9.5	230V	1CT	10	P3 Technology	Bi-Plane	14000	Univerzální	6	D	185235 25
6638P	650W	GY9.5	230V	1CT	10	P3 Technology	Bi-Plane	16500	Univerzální	7	B	184481 25
6638P	650W	GY9.5	240V	1CT	10	P3 Technology	Bi-Plane	16500	Univerzální	7	B	184511 25
6827Z	750W	G22	120V	1CT	10	P3 Technology	Bi-Plane	20000	Univerzální	8	A	186072 25
6827C	750W	P28s	120V	1CT	10	P3 Technology	Bi-Plane	20000	Univerzální	9	E	504371 25
7001C	750W	P28s	120V	1CT	10	P3 Technology	Bi-Plane	17500	Univerzální	10	E	506597 25
6983P	1000W	G9.5	120V	1CT	10	P3 Technology	Coiled Coil	27000	Univerzální	11	C	194671 25
6983P	1000W	G9.5	230V	1CT	10	P3 Technology	Coiled Coil	26000	Univerzální	11	C	184665 25
6983P	1000W	G9.5	240V	1CT	10	P3 Technology	Coiled Coil	26000	Univerzální	11	C	184696 25
6995Z	1000W	G22	120V	1CT	10	P3 Technology	Bi-Plane	27000	Univerzální	12	A	185624 25
6995Z	1000W	G22	230V	1CT	10	P3 Technology	Bi-Plane	25000	Univerzální	13	A	185655 25
6995Z	1000W	G22	240V	1CT	10	P3 Technology	Bi-Plane	25000	Univerzální	13	A	185686 25
6995Y	1000W	G38	120V	1CT	10	-	Bi-Plane	27000	S90	14	F	186492 25
6984P	1000W	GX9.5	230V	1CT	10	P3 Technology	Bi-Plane	22500	Univerzální	15	D	185297 25
6995P	1000W	GX9.5	230V	1CT	10	P3 Technology	Bi-Plane	25000	Univerzální	16	G	185112 25
6995P	1000W	GX9.5	240V	1CT	10	P3 Technology	Bi-Plane	25000	Univerzální	16	G	185143 25
6995C	1000W	P28s	120V	1CT	10	P3 Technology	Bi-Plane	27000	Univerzální	17	E	504388 25
6975Z	2000W	G22	230V	1CT	10	-	Bi-Plane	50000	S90	18	A	504753 25
6994Y	2000W	G22	230V	1CT	10	-	Bi-Plane	50000	S90	19	A	506573 25
6975Z	2000W	G22	240V	1CT	10	-	Bi-Plane	50000	S90	18	A	504760 25
6994Z	2000W	G38	120V	1CT	10	-	Bi-Plane	54000	S90	20	F	186225 25
6994Z	2000W	G38	230V	1CT	10	-	Bi-Plane	50000	S90	20	F	186553 25
6994Z	2000W	G38	240V	1CT	10	-	Bi-Plane	50000	S90	20	F	186584 25
6994P	2000W	GY16	230V	1CT	10	-	Bi-Plane	50000	S90	21	H	185839 25
6994P	2000W	GY16	240V	1CT	10	-	Bi-Plane	50000	S90	21	H	185860 25
6894Y	2500W	G22	230V	1CT	10	-	Bi-Plane	65000	S90	22	A	506481 25
6894Y	2500W	G22	240V	1CT	10	-	Bi-Plane	65000	S90	22	A	506498 25

## Žárovky pro speciální aplikace - Broadway ⇒ Broadway halogenové žárovky Broadway Studio/Film jednopaticové

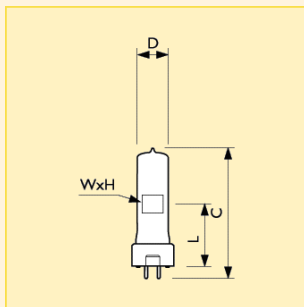

Rozměry (mm)

Obr. č.	C	D	L	WxH
	max.	max.	nom.	nom.
1	90	18	46.5	6x13
2	75	22	36.5	11x11
3	90	18	46.5	8x18
7	90	22	46.5	11x12

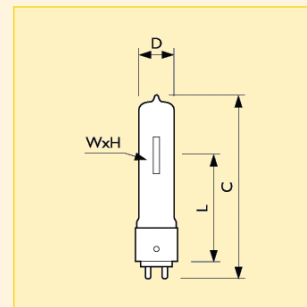

Rozměry (mm)

Obr. č.	C	D	L	WxH
	max.	max.	nom.	nom.
4	105	20	60.5	8x18
11	105	20	60.5	7x21

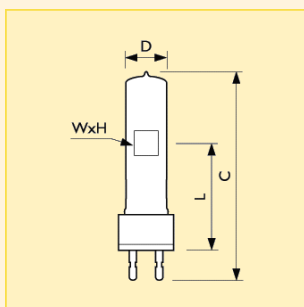

Rozměry (mm)

Obr. č.	C	D	L	WxH
	max.	max.	nom.	nom.
5	140	22	63.5	11x12
8	140	28	63.5	11x10
12	140	28	63.5	15x13
13	140	28	63.5	11x14
18	175	40	90	14x13
19	160	40	75	20x20
22	175	40	90	20x21

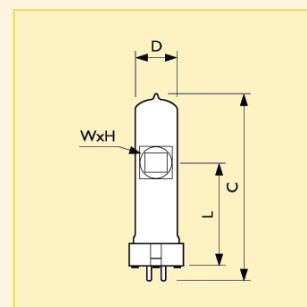

Rozměry (mm)

Obr. č.	C	D	L	WxH
	max.	max.	nom.	nom.
6	110	22	55	11x10
15	110	28	55	15x13

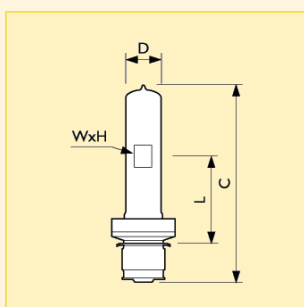

Rozměry (mm)

Obr. č.	C	D	L	WxH
	max.	max.	nom.	nom.
9	127	22	55.6	11x14
10	127	22	55.6	11x12
17	127	28	55.6	11x14

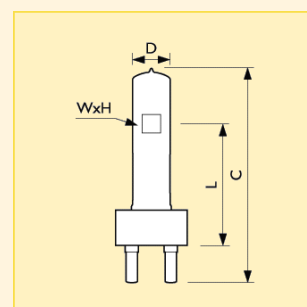

Rozměry (mm)

Obr. č.	C	D	L	WxH
	max.	max.	nom.	nom.
14	200	30.5	127	15x13
20	210	40	127	18x18

## Žárovky pro speciální aplikace - Broadway ⇒ Broadway halogenové žárovky Broadway Studio/Film jednopaticové

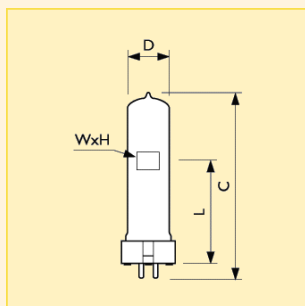

Rozměry (mm)

Obr. č.	C max.	D max.	L nom.	WxH nom.
16	110	28	55	15x13

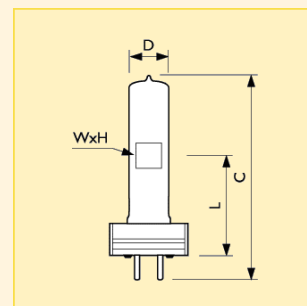

Rozměry (mm)

Obr. č.	C max.	D max.	L nom.	WxH nom.
21	145	40	70	18x18

### Technická data

Název produktu	Finální úprava baňky	Philips kód	ANSI	LIF	Životnost při 50% selhání (h)
6872P 300W GY9.5 230V	Čirá	6872P	FSL	CP/81	180
6872P 300W GY9.5 240V	Čirá	6872P	FSK	CP/81	180
7389 500W GY9.5 230V	Čirá	7389	-	A1/244	75
6873P 500W GY9.5 230V	Čirá	6873P	FRH	CP/82	180
7389 500W GY9.5 240V	Čirá	7389	-	A1/244	75
6873P 500W GY9.5 240V	Čirá	6873P	FRJ	CP/82	180
6985P 575W G9.5 115V	Čirá	6985P	FLK	-	300
6993Z 650W G22 230V	Čirá	6993Z	FKH	CP/68 (CP/39)	120
6999P 650W GX9.5 230V	Reflektor	6999P	-	CP/65	125
6638P 650W GY9.5 230V	Čirá	6638P	FRL	CP/89	180
6638P 650W GY9.5 240V	Čirá	6638P	FRM	CP/89	180
6827Z 750W G22 120V	Čirá	6827Z	EGR	-	200
6827C 750W P28s 120V	Čirá	6827C	BTP	-	200
7001C 750W P28s 120V	Čirá	7001C	BTN	-	500
6983P 1000W G9.5 120V	Čirá	6983P	FEL	CP/77	300
6983P 1000W G9.5 230V	Čirá	6983P	FEP	CP/77	180
6983P 1000W G9.5 240V	Čirá	6983P	FEP	CP/77	180
6995Z 1000W G22 120V	Čirá	6995Z	EGT	-	240
6995Z 1000W G22 230V	Čirá	6995Z	FKJ	CP/71 (CP/40)	240
6995Z 1000W G22 240V	Čirá	6995Z	FKJ	CP/71 (CP/40)	240
6995Y 1000W G38 120V	Čirá	6995Y	CYV	-	240
6984P 1000W GX9.5 230V	Reflektor	6984P	-	CP/63	180
6995P 1000W GX9.5 230V	Čirá	6995P	FVA	CP/70 (CP/24)	240
6995P 1000W GX9.5 240V	Čirá	6995P	FVB	CP/70 (CP/24)	240
6995C 1000W P28s 120V	Čirá	6995C	BTR	-	250
6975Z 2000W G22 230V	Čirá	6975Z	-	CP/92	400
6994Y 2000W G22 230V	Čirá	6994Y	-	CP/75 (CP/55)	480
6975Z 2000W G22 240V	Čirá	6975Z	-	CP/92	400
6994Z 2000W G38 120V	Čirá	6994Z	CYX	-	420
6994Z 2000W G38 230V	Čirá	6994Z	FKK/FKP	CP/73 (CP/41)	480
6994Z 2000W G38 240V	Čirá	6994Z	FKK/FKP	CP/73 (CP/41)	480
6994P 2000W GY16 230V	Čirá	6994P	FTM	CP/72 (CP/43)	480
6994P 2000W GY16 240V	Čirá	6994P	FTL	CP/72 (CP/43)	480
6894Y 2500W G22 230V	Čirá	6894Y	-	CP/91	400
6894Y 2500W G22 240V	Čirá	6894Y	-	CP/91	400

Název produktu	Max. teplota stisku (°C)	Rapid Acting HBC Fuse (V)	Stmívatelný	Použití
6872P 300W GY9.5 230V	350	2.0	Ano	Entertainment
6872P 300W GY9.5 240V	350	2.0	Ano	Entertainment
7389 500W GY9.5 230V	400	4.0	Ano	Entertainment
6873P 500W GY9.5 230V	350	4.0	Ano	Entertainment
7389 500W GY9.5 240V	400	4.0	Ano	Entertainment
6873P 500W GY9.5 240V	350	4.0	Ano	Entertainment
6985P 575W G9.5 115V	500	10.0	Ano	Entertainment
6993Z 650W G22 230V	500	4.0	Ano	Entertainment

Více informací na následující straně

## Žárovky pro speciální aplikace - Broadway ⇒ Broadway halogenové žárovky Broadway Studio/Film jednopaticové

Název produktu	Max. teplota stisku (°C)	Rapid Acting HBC Fuse (V)	Stmívatelný	Použití
6999P 650W GX9.5 230V	500	4.0	Ano	Entertainment
6638P 650W GY9.5 230V	500	4.0	Ano	Entertainment
6638P 650W GY9.5 240V	500	4.0	Ano	Entertainment
6827Z 750W G22 120V	500	10.0	Ano	Entertainment
6827C 750W P28s 120V	500	10.0	Ano	Entertainment
7001C 750W P28s 120V	500	6.3	Ano	Entertainment
6983P 1000W G9.5 120V	500	10.0	Ano	Entertainment
6983P 1000W G9.5 230V	500	6.3	Ano	Entertainment
6983P 1000W G9.5 240V	500	6.3	Ano	Entertainment
6995Z 1000W G22 120V	500	10.0	Ano	Entertainment
6995Z 1000W G22 230V	500	6.3	Ano	Entertainment
6995Z 1000W G22 240V	500	6.3	Ano	Entertainment
6995Y 1000W G38 120V	400	16.0	Ano	Entertainment
6984P 1000W GX9.5 230V	500	6.3	Ano	Entertainment
6995P 1000W GX9.5 230V	500	6.3	Ano	Entertainment
6995P 1000W GX9.5 240V	500	6.3	Ano	Entertainment
6995C 1000W P28s 120V	500	10.0	Ano	Entertainment
6975Z 2000W G22 230V	400	16.0	Ano	Entertainment
6994Y 2000W G22 230V	400	16.0	Ano	Entertainment
6975Z 2000W G22 240V	400	16.0	Ano	Entertainment
6994Z 2000W G38 120V	400	25.0	Ano	Entertainment
6994Z 2000W G38 230V	400	16.0	Ano	Entertainment
6994Z 2000W G38 240V	400	16.0	Ano	Entertainment
6994P 2000W GY16 230V	400	16.0	Ano	Entertainment
6994P 2000W GY16 240V	400	16.0	Ano	Entertainment
6894Y 2500W G22 230V	400	16.0	Ano	Entertainment
6894Y 2500W G22 240V	400	16.0	Ano	Entertainment

### Logistická data

Název produktu	Typ balení	Popis obalu	Počet ks v balení	Uspořádání balení	Množství v balení	Délka balení (mm)	Šířka balení (mm)	Výška balení (mm)	Celková váha 1 ks (g)	Netto hmotnost 1ks (g)
6872P 300W GY9.5 230V	1CT	1 Carton	10	10	1	255	106	140	-	18
6872P 300W GY9.5 240V	1CT	1 Carton	10	10	1	255	106	140	-	18
7389 500W GY9.5 230V	1CT	1 Carton	10	10	1	255	106	140	-	21
6873P 500W GY9.5 230V	1CT	1 Carton	10	10	1	255	106	140	-	18
7389 500W GY9.5 240V	1CT	1 Carton	10	10	1	255	106	140	-	21
6873P 500W GY9.5 240V	1CT	1 Carton	10	10	1	255	106	140	-	18
6985P 575W G9.5 115V	1CT	1 Carton	10	10	1	272	116	175	-	26
6993Z 650W G22 230V	1CT	1 Carton	10	10	1	326	136	230	-	84
6999P 650W GX9.5 230V	1CT	1 Carton	10	10	1	272	116	175	-	39
6638P 650W GY9.5 230V	1CT	1 Carton	10	10	1	255	106	140	-	25
6638P 650W GY9.5 240V	1CT	1 Carton	10	10	1	255	106	140	-	25
6827Z 750W G22 120V	1CT	1 Carton	10	10	1	326	136	230	-	91
6827C 750W P28s 120V	1CT	1 Carton	10	10	1	326	136	230	-	50
7001C 750W P28s 120V	1CT	1 Carton	10	10	1	326	136	230	-	50
6983P 1000W G9.5 120V	1CT	1 Carton	10	10	1	272	116	175	-	26
6983P 1000W G9.5 230V	1CT	1 Carton	10	10	1	272	116	175	-	26
6983P 1000W G9.5 240V	1CT	1 Carton	10	10	1	272	116	175	-	26
6995Z 1000W G22 120V	1CT	1 Carton	10	10	1	326	136	230	-	88
6995Z 1000W G22 230V	1CT	1 Carton	10	10	1	326	136	230	-	88
6995Z 1000W G22 240V	1CT	1 Carton	10	10	1	326	136	230	-	88
6995Y 1000W G38 120V	1CT	1 Carton	10	10	1	350	146	295	-	250
6984P 1000W GX9.5 230V	1CT	1 Carton	10	10	1	272	116	175	-	39
6995P 1000W GX9.5 230V	1CT	1 Carton	10	10	1	272	116	175	-	39
6995P 1000W GX9.5 240V	1CT	1 Carton	10	10	1	272	116	175	-	39
6995C 1000W P28s 120V	1CT	1 Carton	10	10	1	326	136	230	-	50
6975Z 2000W G22 230V	1CT	1 Carton	10	10	1	350	146	295	-	250
6994Y 2000W G22 230V	1CT	1 Carton	10	10	1	326	136	230	-	80
6975Z 2000W G22 240V	1CT	1 Carton	10	10	1	350	146	295	-	250
6994Z 2000W G38 120V	1CT	1 Carton	10	10	1	350	146	295	-	250
6994Z 2000W G38 230V	1CT	1 Carton	10	10	1	350	146	295	-	250
6994Z 2000W G38 240V	1CT	1 Carton	10	10	1	350	146	295	-	250
6994P 2000W GY16 230V	1CT	1 Carton	10	10	1	326	136	230	139	73
6994P 2000W GY16 240V	1CT	1 Carton	10	10	1	326	136	230	-	73
6894Y 2500W G22 230V	1CT	1 Carton	10	10	1	350	146	295	-	250
6894Y 2500W G22 240V	1CT	1 Carton	10	10	1	350	146	295	-	250

## Žárovky pro speciální aplikace - Broadway ⇒ Broadway halogenové žárovky Broadway Studio/Film jednopaticové

### Patice

GY9.5

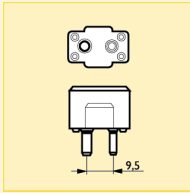

G9.5

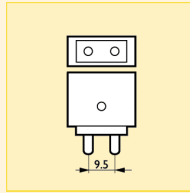

G22

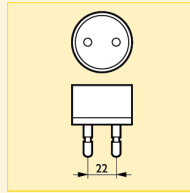

GX9.5

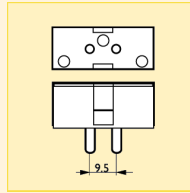

P28s

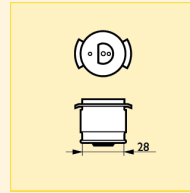

G38

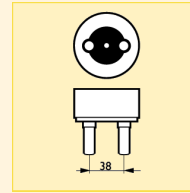

GY16

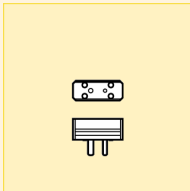

### Poloha svícení

Univerzální S90

